

## General Description

The WSC5N20 is the highest performance trench N-ch MOSFET with extreme high cell density, which provide excellent RDSON and gate charge for most of the synchronous buck converter applications.

The WSC5N20 meet the RoHS and Green Product requirement, 100% EAS guaranteed with full function reliability approved.

## Features

- Advanced high cell density Trench technology
- Super Low Gate Charge
- Excellent CdV/dt effect decline
- 100% EAS Guaranteed
- Green Device Available

## Product Summary

BVDSS	RDSON	ID
200V	0.49Ω	5A

## Applications

- High Frequency Point-of-Load Synchronous Buck Converter for MB/NB/UMPC/VGA
- Networking DC-DC Power System
- Load Switch

## TO-251 Pin Configuration

## Absolute Maximum Ratings

Symbol	Parameter	Rating	Units
V <sub>DS</sub>	Drain-Source Voltage	200	V
V <sub>GS</sub>	Gate-Source Voltage	±30	V
I <sub>D</sub> @T <sub>C</sub> =25°C	Continuous Drain Current, V <sub>GS</sub> @ 10V <sup>1</sup>	5	A
I <sub>D</sub> @T <sub>C</sub> =100°C	Continuous Drain Current, V <sub>GS</sub> @ 10V <sup>1</sup>	3.24	A
I <sub>D</sub> @T <sub>A</sub> =25°C	Continuous Drain Current, V <sub>GS</sub> @ 10V <sup>1</sup>	1	A
I <sub>D</sub> @T <sub>A</sub> =70°C	Continuous Drain Current, V <sub>GS</sub> @ 10V <sup>1</sup>	0.5	A
I <sub>DM</sub>	Pulsed Drain Current <sup>2</sup>	20	A
EAS	Single Pulse Avalanche Energy <sup>3</sup>	125	mJ
I <sub>AS</sub>	Avalanche Current	10	A
P <sub>D</sub> @T <sub>C</sub> =25°C	Total Power Dissipation <sup>4</sup>	78	W
P <sub>D</sub> @T <sub>A</sub> =25°C	Total Power Dissipation <sup>4</sup>	2.5	W
T <sub>STG</sub>	Storage Temperature Range	-55 to 175	°C
T <sub>J</sub>	Operating Junction Temperature Range	-55 to 175	°C

## Thermal Data

Symbol	Parameter	Typ.	Max.	Unit
R <sub>θJA</sub>	Thermal Resistance Junction-ambient (Steady State) <sup>1</sup>	---	62	°C/W
R <sub>θJA</sub>	Thermal Resistance Junction-Ambient <sup>1</sup> (t ≤ 10s)	---	25	°C/W
R <sub>θJC</sub>	Thermal Resistance Junction-Case <sup>1</sup>	---	2.8	°C/W

**Electrical Characteristics (T<sub>J</sub>=25 °C, unless otherwise noted)**

Symbol	Parameter	Conditions	Min.	Typ.	Max.	Unit
BV <sub>DSS</sub>	Drain-Source Breakdown Voltage	V <sub>GS</sub> =0V, I <sub>D</sub> =250uA	200	---	---	V
ΔBV <sub>DSS</sub> /ΔT <sub>J</sub>	BVDSS Temperature Coefficient	Reference to 25°C, I <sub>D</sub> =1mA	---	0.028	---	V/°C
R <sub>DS(ON)</sub>	Static Drain-Source On-Resistance <sup>2</sup>	V <sub>GS</sub> =10V, I <sub>D</sub> =30A	---	0.49	0.58	Ω
V <sub>GS(th)</sub>	Gate Threshold Voltage	V <sub>GS</sub> =V <sub>DS</sub> , I <sub>D</sub> =250uA	2.0	---	4.0	V
ΔV <sub>GS(th)</sub>	V <sub>GS(th)</sub> Temperature Coefficient		---	-6.16	---	mV/°C
I <sub>DSS</sub>	Drain-Source Leakage Current	V <sub>DS</sub> =200V, V <sub>GS</sub> =0V, T <sub>J</sub> =25°C	---	---	1	uA
		V <sub>DS</sub> =160V, V <sub>GS</sub> =0V, T <sub>J</sub> =55°C	---	---	5	
I <sub>GSS</sub>	Gate-Source Leakage Current	V <sub>GS</sub> =±30V, V <sub>DS</sub> =0V	---	---	±100	nA
g <sub>fs</sub>	Forward Transconductance	V <sub>DS</sub> =30V, I <sub>D</sub> =2.5A	---	5.2	---	S
R <sub>g</sub>	Gate Resistance	V <sub>DS</sub> =0V, V <sub>GS</sub> =0V, f=1MHz	---	1.7	---	Ω
Q <sub>g</sub>	Total Gate Charge (4.5V)	V <sub>DS</sub> =160V, V <sub>GS</sub> =5V, I <sub>D</sub> =5A	---	10.8	---	nC
Q <sub>gs</sub>	Gate-Source Charge		---	1.7	---	
Q <sub>gd</sub>	Gate-Drain Charge		---	3.1	---	
T <sub>d(on)</sub>	Turn-On Delay Time	V <sub>DD</sub> =100V, V <sub>GS</sub> =10V, R <sub>G</sub> =10Ω I <sub>D</sub> =5A,	---	7.33	---	ns
T <sub>r</sub>	Rise Time		---	10.7	---	
T <sub>d(off)</sub>	Turn-Off Delay Time		---	18.2	---	
T <sub>f</sub>	Fall Time		---	11.9	---	
C <sub>iss</sub>	Input Capacitance	V <sub>DS</sub> =100V, V <sub>GS</sub> =0V, f=1MHz	---	255	---	pF
C <sub>oss</sub>	Output Capacitance		---	30.2	---	
C <sub>rss</sub>	Reverse Transfer Capacitance		---	2.3	---	

**Guaranteed Avalanche Characteristics**

Symbol	Parameter	Conditions	Min.	Typ.	Max.	Unit
EAS	Single Pulse Avalanche Energy <sup>5</sup>	V <sub>DD</sub> =100V, L=0.1mH, I <sub>AS</sub> =10A	100	---	---	mJ

**Diode Characteristics**

Symbol	Parameter	Conditions	Min.	Typ.	Max.	Unit
I <sub>S</sub>	Continuous Source Current <sup>1,6</sup>	V <sub>G</sub> =V <sub>D</sub> =0V, Force Current	---	---	5	A
I <sub>SM</sub>	Pulsed Source Current <sup>2,6</sup>		---	---	20	A
V <sub>SD</sub>	Diode Forward Voltage <sup>2</sup>	V <sub>GS</sub> =0V, I <sub>S</sub> =1A, T <sub>J</sub> =25°C	---	---	1.4	V
t <sub>rr</sub>	Reverse Recovery Time	IF=5A, di/dt=100A/μs, T <sub>J</sub> =25°C	---	125.5	---	nS
Q <sub>rr</sub>	Reverse Recovery Charge		---	357	---	nC

Note :

- 1.The data tested by surface mounted on a 1 inch<sup>2</sup> FR-4 board with 2OZ copper,t<10sec.
- 2.The data tested by pulsed , pulse width ≤ 300us , duty cycle ≤ 2%
- 3.The EAS data shows Max. rating . The test condition is V<sub>DD</sub>=100V,V<sub>GS</sub>=10V,L=0.1mH,I<sub>AS</sub>=10A
- 4.The power dissipation is limited by 175°C junction temperature
- 5.The Min. value is 100% EAS tested guarantee.
- 6.The data is theoretically the same as I<sub>D</sub> and I<sub>DM</sub> , in real applications , should be limited by total power dissipation.

**Typical Characteristics**

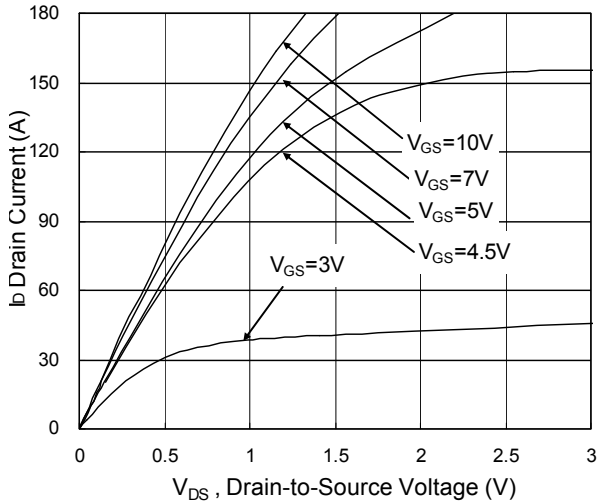

**Fig.1 Typical Output Characteristics**

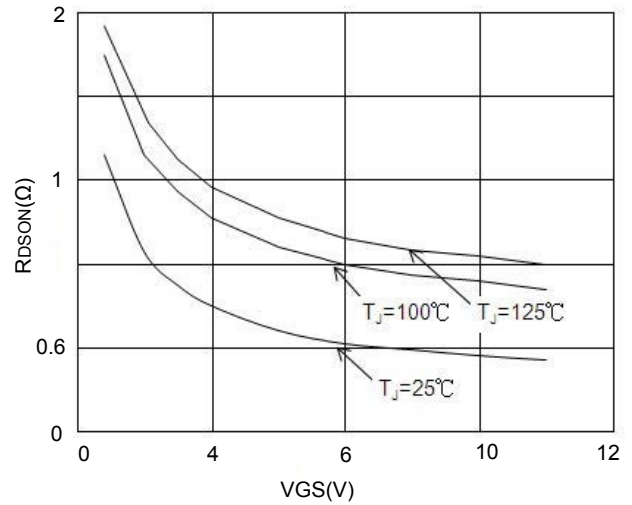

**Fig.2 On-Resistance vs. G-S Voltage**

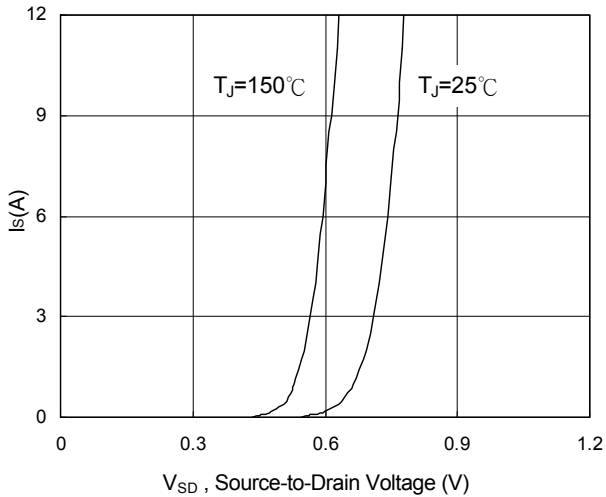

**Fig.3 Forward Characteristics of Reverse**

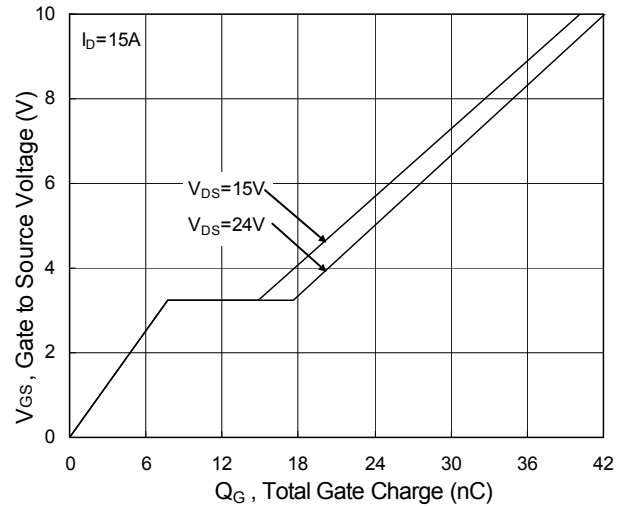

**Fig.4 Gate-Charge Characteristics**

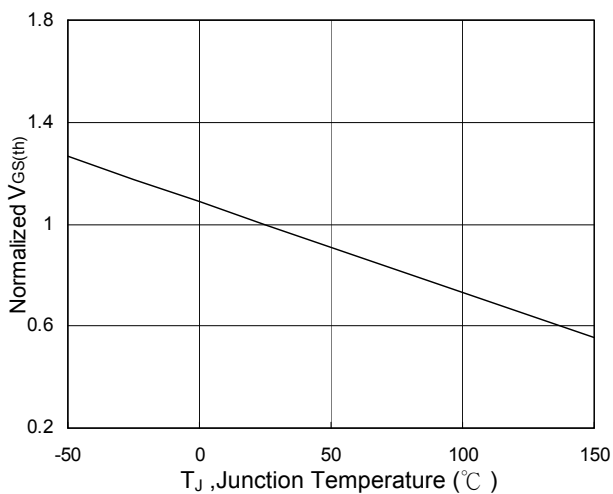

**Fig.5 Normalized  $V_{GS(th)}$  vs.  $T_J$**

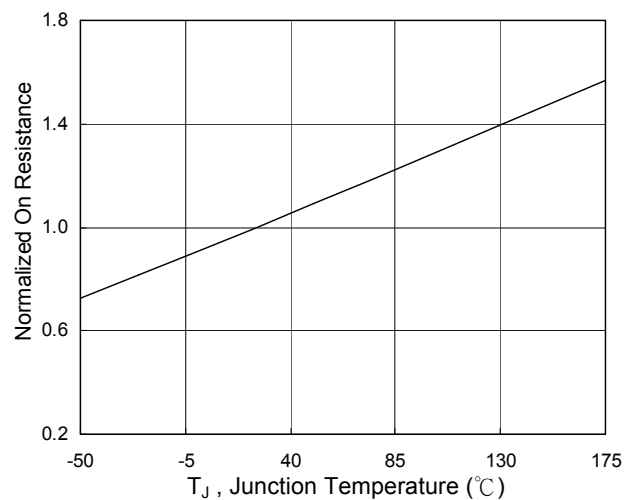

**Fig.6 Normalized  $R_{DS(on)}$  vs.  $T_J$**

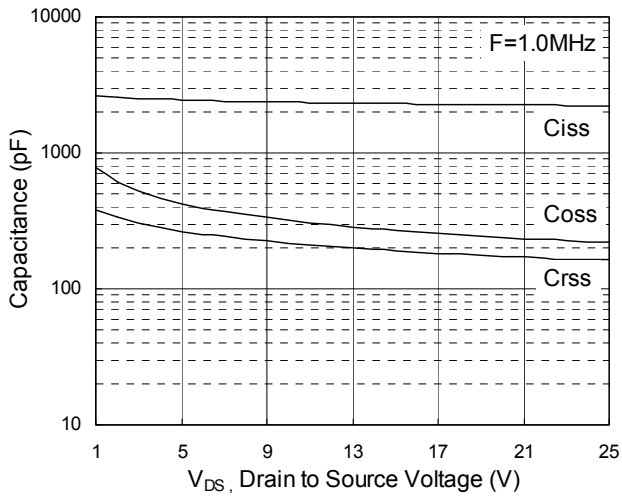

**Fig.7 Capacitance**

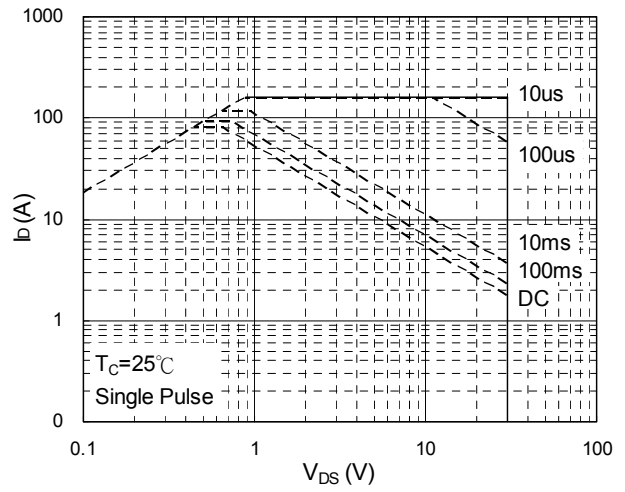

**Fig.8 Safe Operating Area**

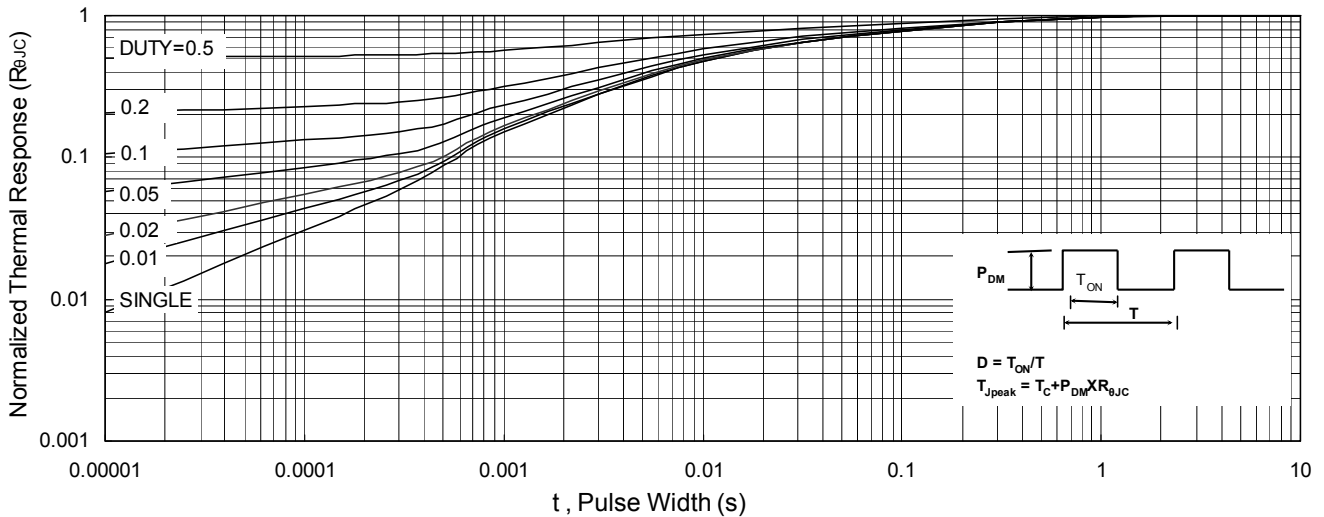

**Fig.9 Normalized Maximum Transient Thermal Impedance**

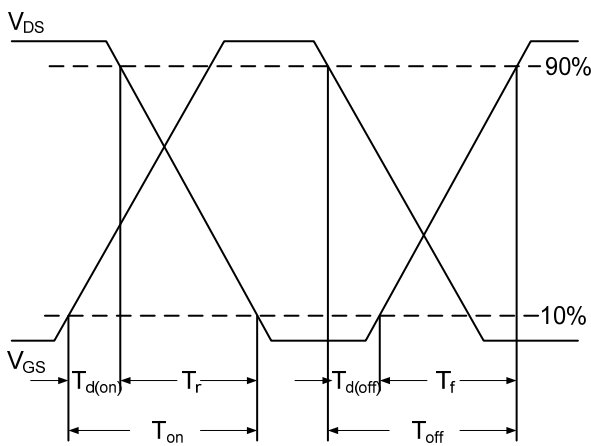

**Fig.10 Switching Time Waveform**

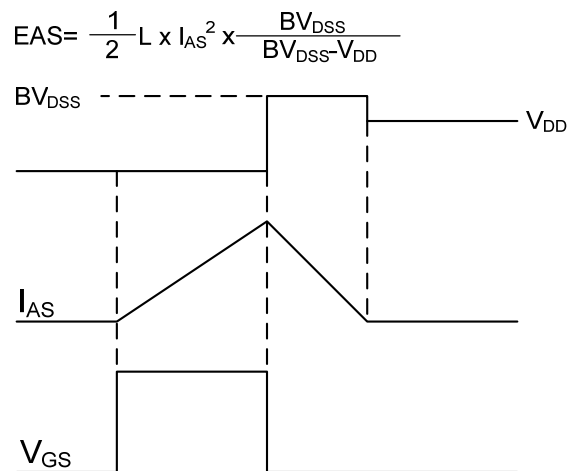

**Fig.11 Unclamped Inductive Switching Waveform**



## Attention

- 1, Any and all Winsok power products described or contained herein do not have specifications that can handle applications that require extremely high levels of reliability, such as life-support systems, aircraft's control systems, or other applications whose failure can be reasonably expected to result in serious physical and/or material damage. Consult with your Winsok power representative nearest you before using any Winsok power products described or contained herein in such applications.
- 2, Winsok power assumes no responsibility for equipment failures that result from using products at values that exceed, even momentarily, rated values (such as maximum ratings, operating condition ranges, or other parameters) listed in products specifications of any and all Winsok power products described or contained herein.
- 3, Specifications of any and all Winsok power products described or contained herein stipulate the performance, characteristics, and functions of the described products in the independent state, and are not guarantees of the performance, characteristics, and functions of the described products as mounted in the customer's products or equipment. To verify symptoms and states that cannot be evaluated in an independent device, the customer should always evaluate and test devices mounted in the customer's products or equipment.
- 4, Winsok power Semiconductor CO., LTD. strives to supply high-quality high-reliability products. However, any and all semiconductor products fail with some probability. It is possible that these probabilistic failures could give rise to accidents or events that could endanger human lives that could give rise to smoke or fire, or that could cause damage to other property. When designing equipment, adopt safety measures so that these kinds of accidents or events cannot occur. Such measures include but are not limited to protective circuits and error prevention circuits for safe design, redundant design, and structural design.
- 5, In the event that any or all Winsok power products (including technical data, services) described or contained herein are controlled under any of applicable local export control laws and regulations, such products must not be exported without obtaining the export license from the authorities concerned in accordance with the above law.
- 6, No part of this publication may be reproduced or transmitted in any form or by any means, electronic or mechanical, including photocopying and recording, or any information storage or retrieval system, or otherwise, without the prior written permission of Winsok power Semiconductor CO., LTD.
- 7, Information (including circuit diagrams and circuit parameters) herein is for example only; it is not guaranteed for volume production. Winsok power believes information herein is accurate and reliable, but no guarantees are made or implied regarding its use or any infringements of intellectual property rights or other rights of third parties.
- 8, Any and all information described or contained herein are subject to change without notice due to product/technology improvement, etc. When designing equipment, refer to the "Delivery Specification" for the Winsok power product that you intend to use.
- 9, this catalog provides information as of Sep. 2014. Specifications and information herein are subject to change without notice.